



**Dual Schottky Barrier Power Rectifier**  
**Reverse Voltage 30 Volts Forward Current 10 Amperes**

Using the Schottky Barrier principle with a Molybdenum barrier metal. These state-of-the-art geometry features epitaxial construction with oxide passivation and metal overlay contact. Ideally suited for low voltage, high frequency rectification, or as free wheeling and polarity protection diodes.

**Features**

- Low Forward Voltage.
- Low Switching noise.
- High Current Capacity
- Guarantee Reverse Avalanche.
- Guard-Ring for Stress Protection.
- Low Power Loss & High efficiency.
- 150°C Operating Junction Temperature
- Low Stored Charge Majority Carrier Conduction.
- Plastic Material used Carries Underwriters Laboratory

**Marking**

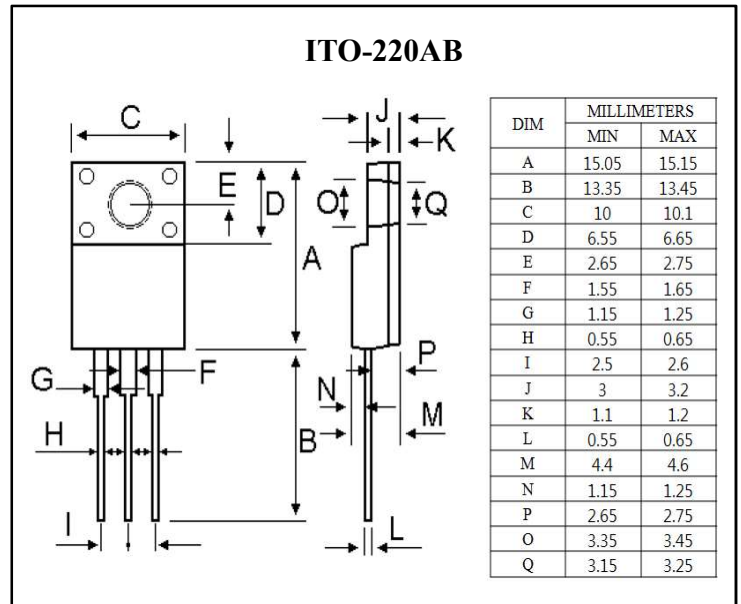
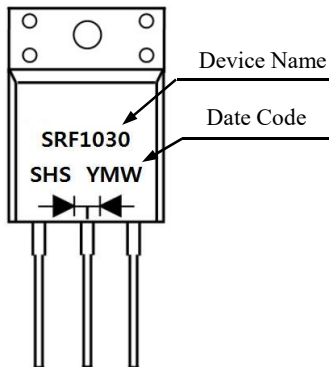

**Equivalent Circuit**

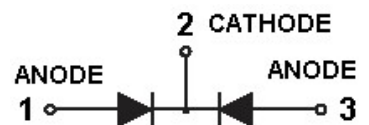

**Maximum Ratings & Electrical Characteristics**

Parameter	Symbol	Rated Value	Unit	Remark
Maximum Repetitive Peak Reverse Voltage	$V_{RRM}$	30	V	
Maximum RMS Voltage	$V_{RMS}$	21	V	
Maximum DC Blocking Voltage	$V_{DC}$	30	V	
Maximum Average Forward Rectified Current Total Device (Rated $V_R$ )	$I_F(AV)$	10	A	
Peak Repetitive Forward Current	$I_{FM}$	10	A	
Peak Forward Surge Current 8.3ms Single Half Sine-wave Superimposed on Rated Load (JEDEC Method)	$I_{FSM}$	175	A	
Maximum Instantaneous Forward Voltage at 5A	$V_F$	0.55	V	$T_a=25^\circ C$
Maximum DC Reverse Current at Rated DC Blocking Voltage	$I_R$	0.5	mA	$T_a=25^\circ C$
		50	mA	$T_a=100^\circ C$
Operation Junction Temperature Range	$T_J$	-55 to +125	$^\circ C$	
Storage Temperature Range	$T_{STG}$	-55 to +150	$^\circ C$	



Ratings and Characteristics Curves ( $T_a=25^\circ\text{C}$  unless otherwise noted)

Fig.1 Forward Current Derating Curve

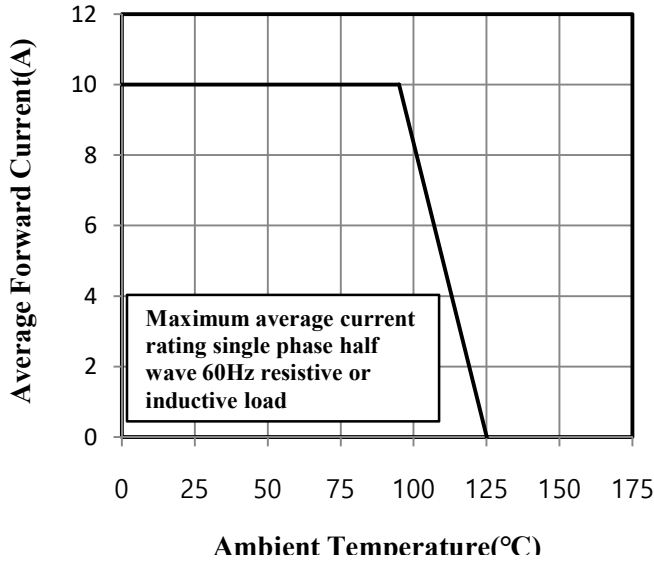

Fig.2 Maximum Non-Repetitive Peak Forward Surge Current

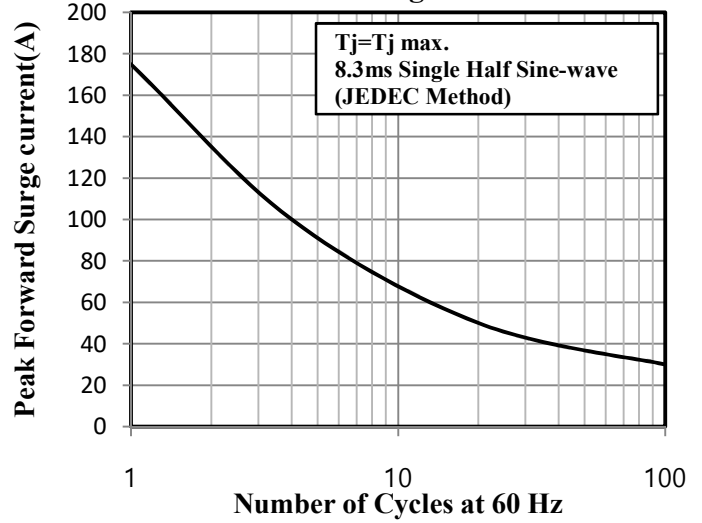

Fig.3 Typical Instantaneous Forward Characteristics

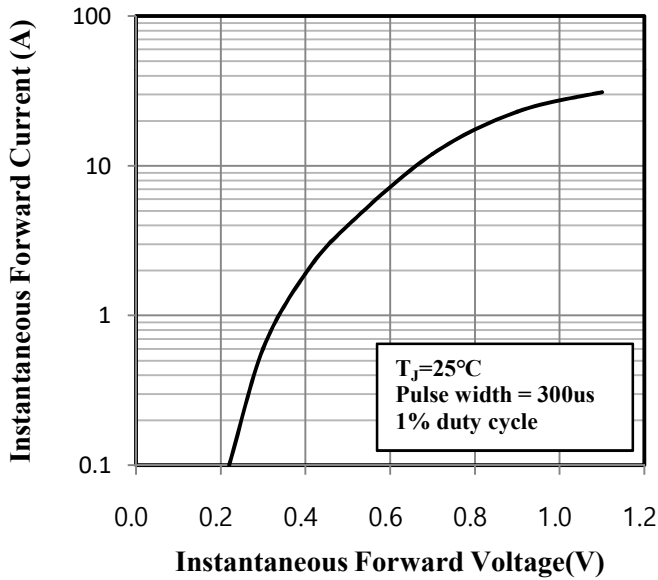

Fig.4 Typical Junction Capacitance

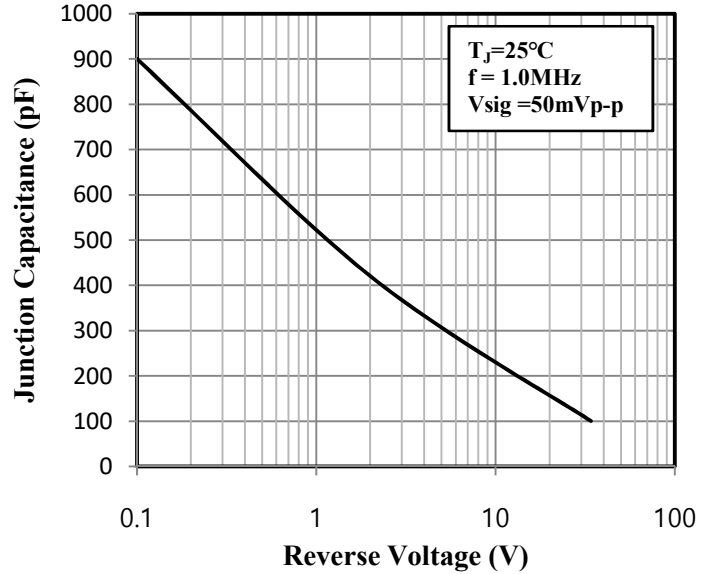

Fig.5 Typical Reverse Characteristics

