



Dual Schottky Barrier Power Rectifier
Reverse Voltage 90 Volts Forward Current 10 Amperes

Using the Schottky Barrier principle with a Molybdenum barrier metal. These state-of-the-art geometry features epitaxial construction with oxide passivation and metal overlay contact. Ideally suited for low voltage, high frequency rectification, or as free wheeling and polarity protection diodes.

Features

- Low Forward Voltage.
- Low Switching noise.
- High Current Capacity
- Guarantee Reverse Avalanche.
- Guard-Ring for Stress Protection.
- Low Power Loss & High efficiency.
- 150°C Operating Junction Temperature
- Low Stored Charge Majority Carrier Conduction.
- Plastic Material used Carries Underwriters Laboratory

Marking

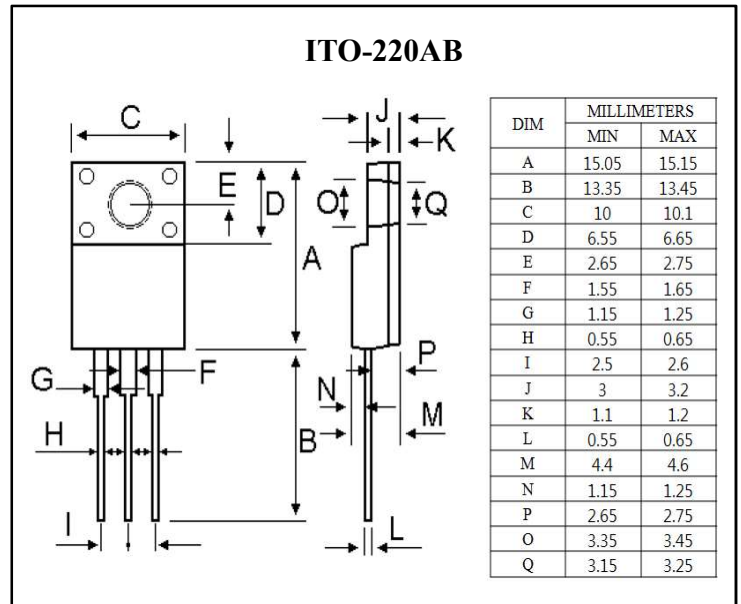
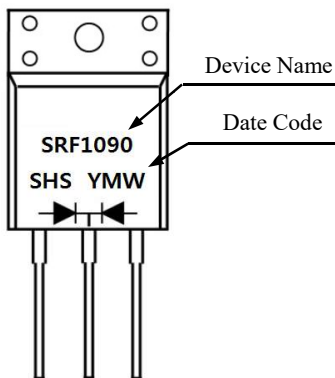

Equivalent Circuit

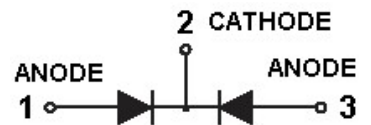

Maximum Ratings & Electrical Characteristics

Parameter	Symbol	Rated Value	Unit	Remark
Maximum Repetitive Peak Reverse Voltage	V_{RRM}	90	V	
Maximum RMS Voltage	V_{RMS}	63	V	
Maximum DC Blocking Voltage	V_{DC}	90	V	
Maximum Average Forward Rectified Current Total Device (Rated V_R)	$I_F(AV)$	5	A	
		10		
Peak Repetitive Forward Current	I_{FM}	10	A	
Peak Forward Surge Current 8.3ms Single Half Sine-wave Superimposed on Rated Load (JEDEC Method)	I_{FSM}	125	A	
Maximum Instantaneous Forward Voltage at 5A	V_F	0.85	V	$T_a=25^\circ C$
Maximum DC Reverse Current at Rated DC Blocking Voltage	I_R	0.5	mA	$T_a=25^\circ C$
		50	mA	$T_a=100^\circ C$
Operation Junction Temperature Range	T_J	-55 to +150	$^\circ C$	
Storage Temperature Range	T_{STG}	-55 to +150	$^\circ C$	



Ratings and Characteristics Curves ($T_a=25^\circ\text{C}$ unless otherwise noted)

Fig.1 Forward Current Derating Curve

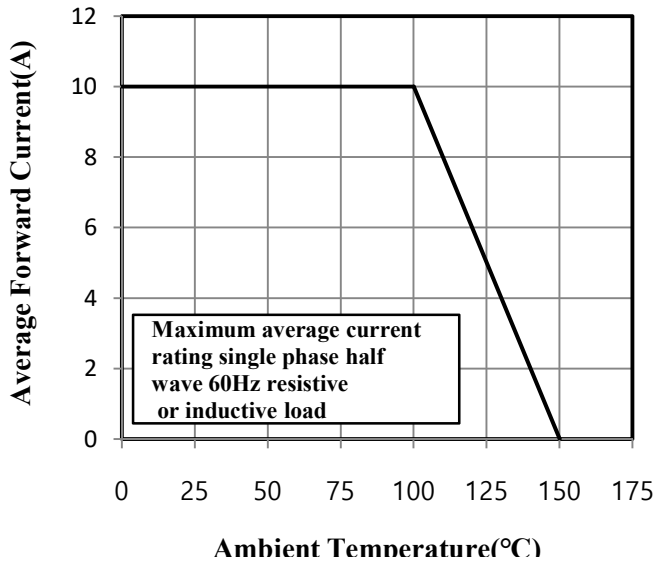

Fig.2 Maximum Non-Repetitive Peak Forward Surge Current

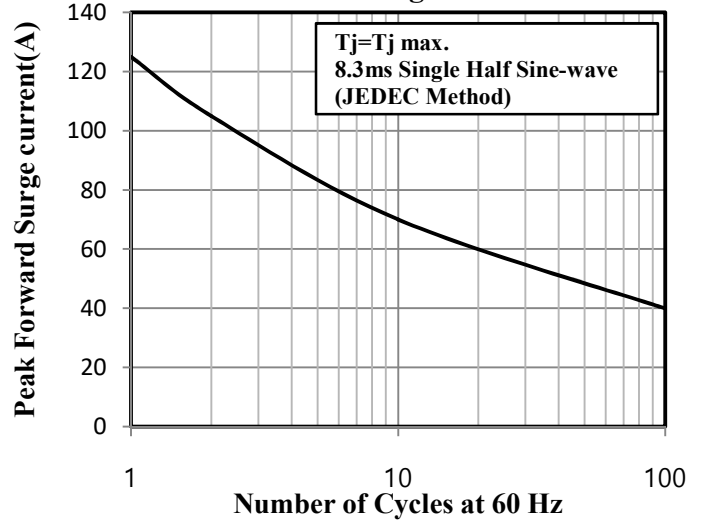

Fig.3 Typical Instantaneous Forward Characteristics

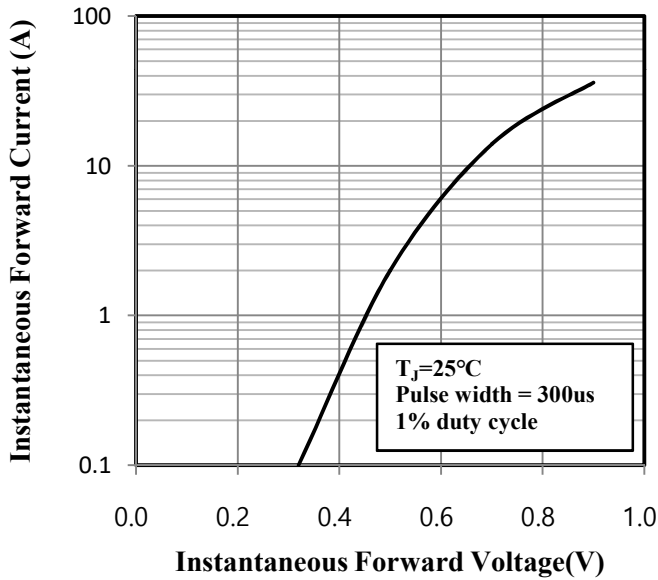

Fig.4 Typical Junction Capacitance

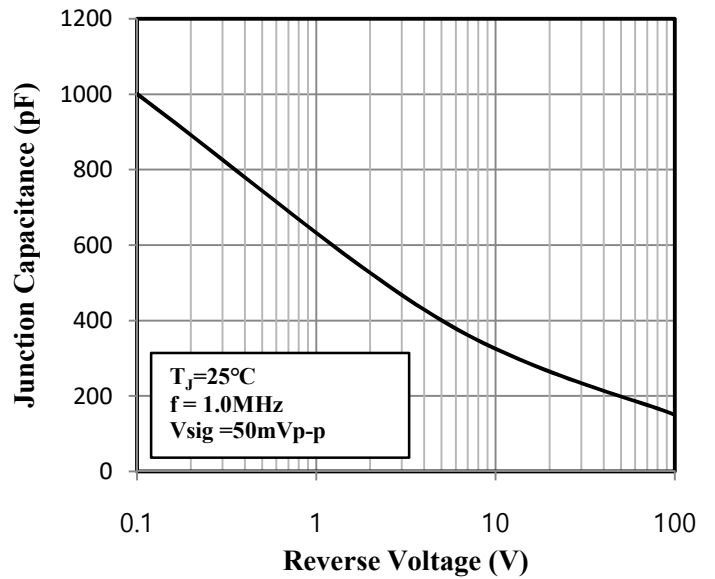

Fig.5 Typical Reverse Characteristics

