



Dual Schottky Barrier Power Rectifier
Reverse Voltage 100 Volts Forward Current 10 Amperes

Using the Schottky Barrier principle with a Refractory metal capable of high temperature operation metal. The proprietary barrier technology allows for reliable operation up to 175°C junction temperature. Typical application are in switching Mode Power Supplies such as adaptors, DC/DC converters, free-wheeling and polarity protection diodes.

Features

- Low Forward Voltage.
- Low Switching noise.
- High Current Capacity
- Guarantee Reverse Avalanche.
- Guard-Ring for Stress Protection.
- Low Power Loss & High efficiency.
- 175°C Operating Junction Temperature
- Low Stored Charge Majority Carrier Conduction.
- Plastic Material used Carries Underwriters Laboratory Flammability Classification 94V-0

Mecanical Data

- Case :JEDEC ITO-220AB molded plastic body
- Termals:Plated lead,solderable per MIL-STD-750, Method 2026
- Polarity:As marked
- Mounting Torqure: 4-6kg.cm
- Weight :2.24 g (approx.)

Maximum Ratings & Electrical Characteristics

Parameter	Symbol	Rated Value	Unit	Remark
Maximum Repetitive Peak Reverse Voltage	V_{RRM}	100	V	
Maximum RMS Voltage	V_{RMS}	70	V	
Maximum DC Blocking Voltage	V_{DC}	100	V	
Maximum Average Forward Rectified Current Total Device (Rated V_R)	$I_F(AV)$	5.0	A	
		10		
Peak Repetitive Forward Current	I_{FM}	10	A	
Peak Forward Surge Current 8.3ms Single Half Sine-wave Superimposed on Rated Load (JEDEC Method)	I_{FSM}	125	A	
Maximum Instantaneous Forward Voltage at 5.0A	V_F	0.85	V	Ta=25°C
	V_F	0.75	V	Ta=125°C
Maximum DC Reverse Current at Rated DC Blocking Voltage	I_R	0.1	mA	Ta=25°C
		10	mA	Ta=125°C
Typical Thermal Resistance Junction to Case	Rth(j-c)	3.8	°C/W	
Operation Junction Temperature Range	T_J	-65 to +175	°C	
Storage Temperature Range	T_{STG}	-65 to +175	°C	

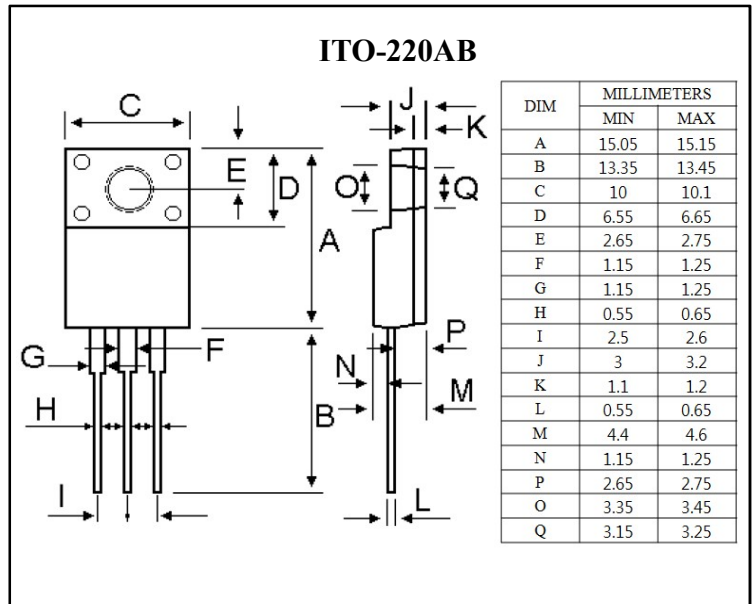

Marking

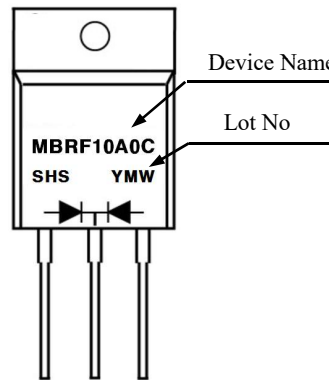

Equivalent Circuit

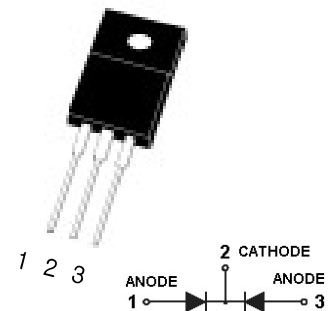



Ratings and Characteristics Curves (Ta=25°C unless otherwise noted)

Fig.1 Forward Current Derating Curve

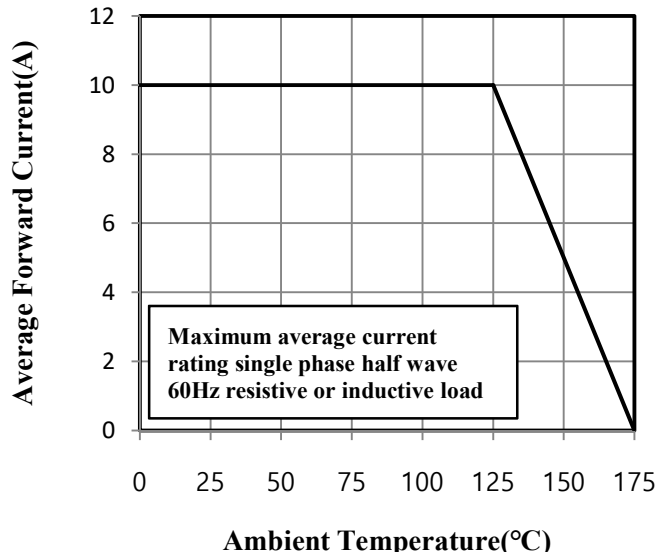

Fig.2 Maximum Non-Repetitive Peak Forward Surge Current

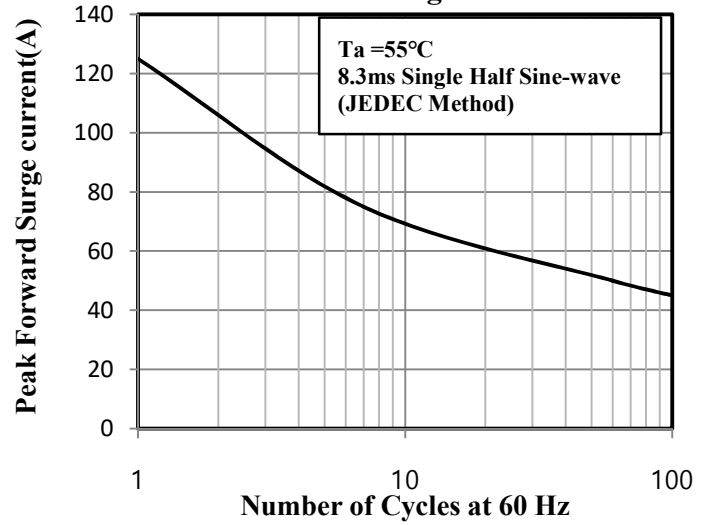

Fig.3 Typical Instantaneous Forward Characteristics

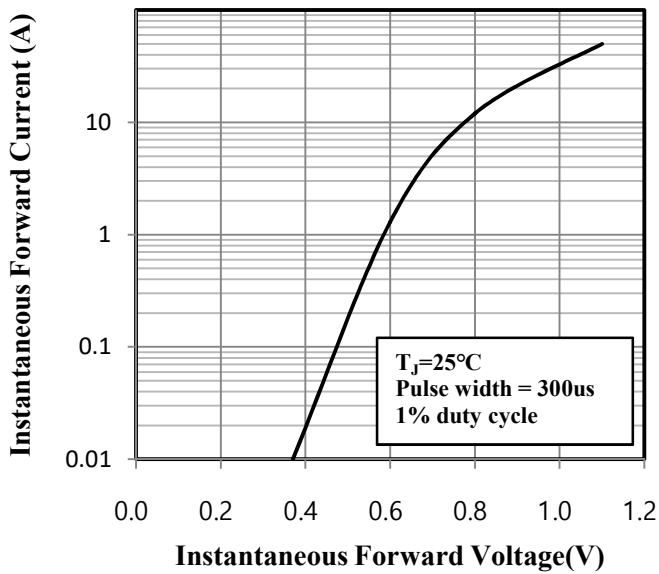

Fig.4 Typical Junction Capacitance

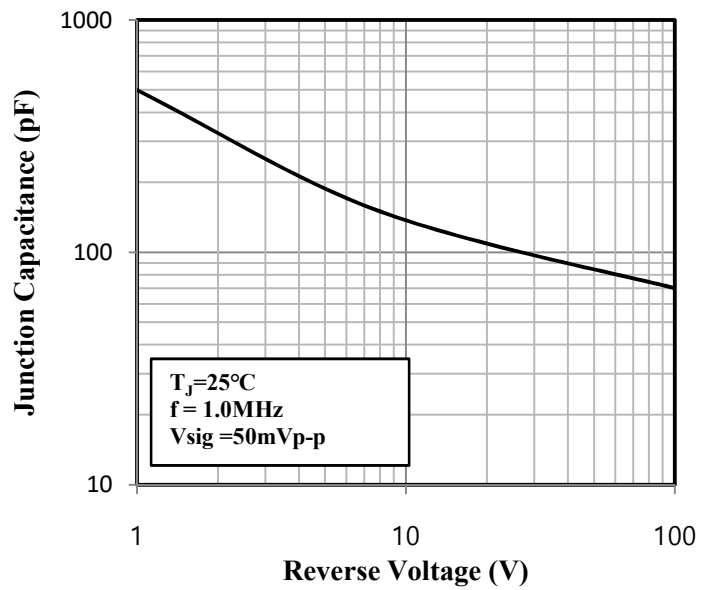

Fig.5 Typical Reverse Characteristics

